



WELCOME TO THE

2026

APPRENTICE CONTEST

APRIL 24-25, 2026
7:00 PM - 4:00 PM

AZ PIPE TRADES APPRENTICESHIP
2950 W. Thomas Rd., Phoenix, AZ



TOMORROW'S LEGENDS START HERE

Each year, our Arizona Pipe Trades Apprenticeship Contest showcases the skill, dedication, and craftsmanship of our future workforce. We welcome you to stop by or stay all day and witness the best of the best, competing for top honors.



CONTEST & OPEN HOUSE SCHEDULE

CONTEST DAY 1 | FRIDAY, APRIL 24, 2026

 = No spectators please

	FITTERS	PLUMBERS	WELDERS	HVAC
7:00 AM	Steamfitting Project <i>Building 5 N&S</i>	 Written Test <i>Room 16</i>	Weld Project <i>Building 4 N&S</i>	 Written Test <i>Room 13</i>
9:00 AM	Steamfitting Project <i>Building 5 N&S</i>	Equal Spread Project <i>Building 6 N</i>	Weld Project <i>Building 4 N&S</i>	Piping Project <i>Building 2 N</i>
11:00 AM	LUNCH <i>Large Room</i>	LUNCH <i>Large Room</i>	LUNCH <i>Large Room</i>	LUNCH <i>Large Room</i>
12:00 PM	Steamfitting Project <i>Building 5 N&S</i>	Equal Spread Project <i>Building 6 N</i>	Weld Project <i>Building 4 N&S</i>	Piping Project <i>Building 2 N</i>
3:30 PM	Debrief & Awards <i>Large Room</i>	Debrief & Awards <i>Large Room</i>	Debrief & Awards <i>Large Room</i>	Debrief & Awards <i>Large Room</i>

CONTEST DAY 2 | SATURDAY, APRIL 25, 2026

	FITTERS	PLUMBERS	WELDERS	HVAC
7:00 AM	Steamfitting Project <i>Building 5 N&S</i>	Rough-In Project <i>Building 6 N</i>	Weld Project <i>Building 4 N&S</i>	Alignment Project <i>Building 2 S</i>
11:00 AM	LUNCH <i>Building 9 Central</i>	LUNCH <i>Building 9 Central</i>	LUNCH <i>Building 9 Central</i>	LUNCH <i>Building 9 Central</i>
12:00 PM	Steamfitting Project <i>Building 5 N&S</i>	Rough-In Project <i>Building 6 N</i>	Weld Project <i>Building 4 N&S</i>	Electrical Project <i>Building 2 S</i>
1:30 PM	 Written Test <i>Room 13</i>	Rough-In Project <i>Building 6 N</i>	Weld Project <i>Building 4 N&S</i>	Electrical Project <i>Building 2 S</i>
2:00 PM	 Written Test <i>Room 13</i>	Rough-In Project <i>Building 6 N</i>	 Written Test <i>Room 16</i>	Electrical Project <i>Building 2 S</i>
3:00 PM	Debrief & Awards <i>Large Room</i>	Debrief & Awards <i>Large Room</i>	Debrief & Awards <i>Large Room</i>	Debrief & Awards <i>Large Room</i>

OPEN HOUSE
SATURDAY, APRIL 25 | 11:00 AM - 4:00 PM

Kid's Piping Project <i>Building 1 N&S</i>	Concessions <i>West of Building 1 N</i>	LUNCH (11 AM-12 PM) <i>Building 9 Central</i>	Awards (3-4 PM) <i>Building 9 Central</i>
---	--	--	--

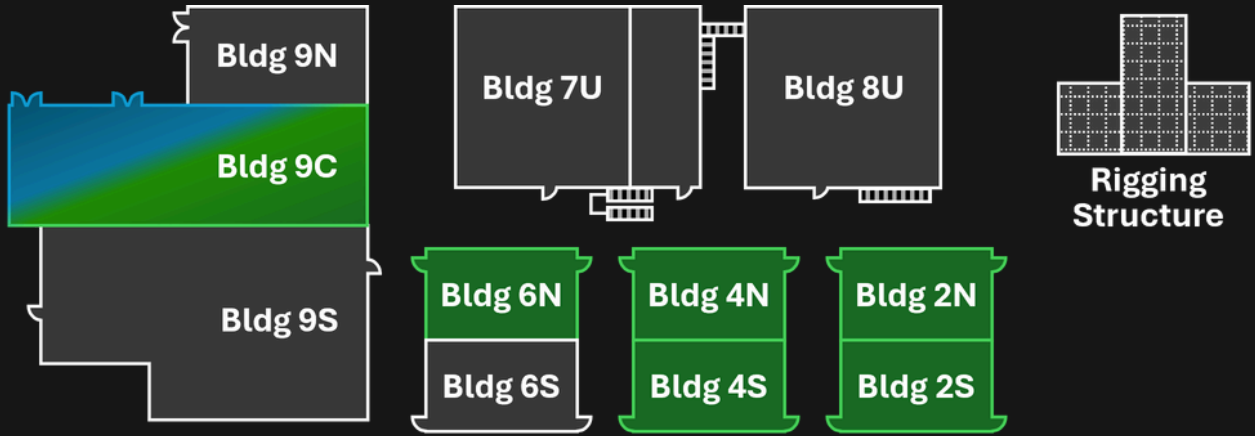

Concessions

Kid's Piping Project



LEGEND



Contest Activities



No Spectators Please



Open House Activities

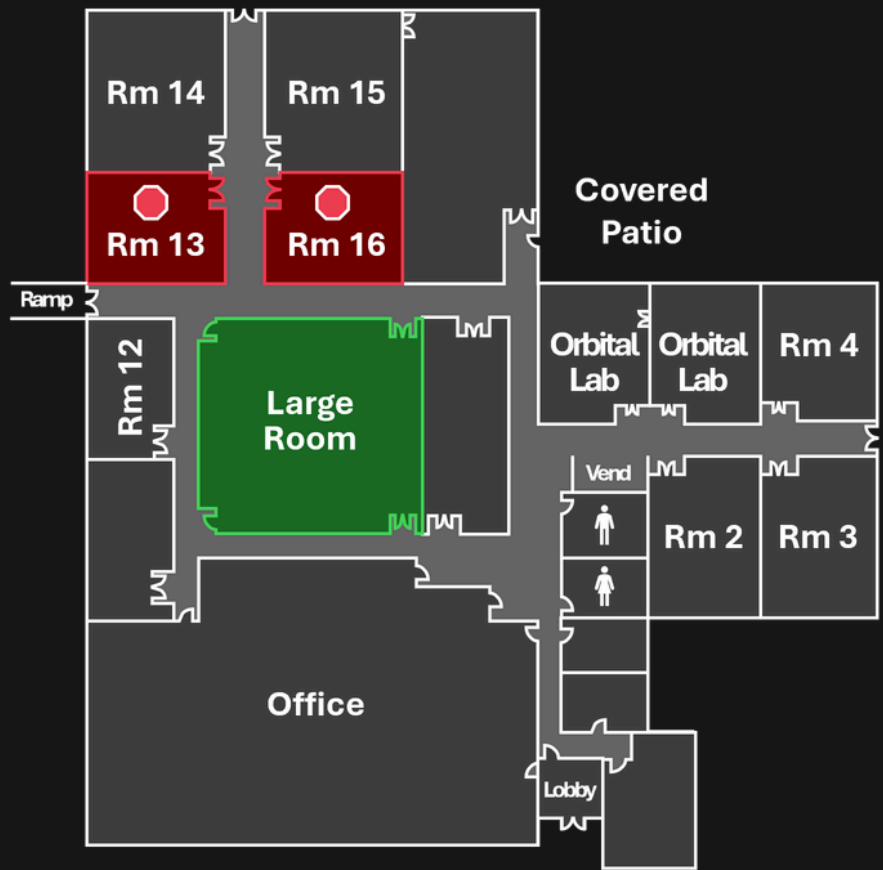

THOMAS RD. ENTRANCE

THOMAS ROAD

2026 PLAYER LINEUP

FITTERS

COMPETITORS

Ivrin James | 5th Yr
 Tyler Kelley | 5th Yr
 Lathal Manygoats | 4th Yr
 Brian Moore | 4th Yr

PROCTORS & JUDGES

Proctor | Charles Custin
 Judge | Eric Clayton
 Judge | Trent Holder

PLUMBERS

COMPETITORS

Jillian Coleman | 5th Yr
 Matthew Duthie | 5th Yr
 Cameron Mayo | 5th Yr
 Justin Morrison | 5th Yr

PROCTORS & JUDGES

Proctor | Brian Baker
 Judge | Jake Saul
 Judge | Kevin Holsome

WELDERS

COMPETITORS

Thomas Cuthbertson | 5th Yr
 Timothy Hakes | 5th Yr
 Skyler Hamilton | 4th Yr
 Zachary Macdonald | 4th Yr

PROCTORS & JUDGES

Proctor | Alicia George
 Judge | John Weber
 Judge | Victor Corrales

HVAC

COMPETITORS

Luis Aguirre-McCave | 3rd Yr
 Benjamin Curdy | 4th Yr
 Dewayne Davis | 4th Yr
 Daniel Ely | 3rd Yr

PROCTORS & JUDGES

Proctor | Richie Barr
 Proctor | Rick Wieting
 Judge | Ross Hanley
 Judge | Matt Leach

LET'S HEAR IT FOR OUR



SPONSORS & DONORS

TITLE SPONSORS



COPPER SPONSORS



STEEL SPONSORS



PRIZE DONORS

